

Preisliste 2023



Bietenholz + Müller GmbH
Konstanzerstrasse 69
9500 Wil SG
071 910 21 51
071 910 21 53
info@bmdrechsleri.ch
www.bmdrechsleri.ch

Inhalt	Seite
Div. Drechslerarbeiten	2
Pfosten gedreht	2
Tischsäulen gedreht	2
Möbelfüße	2
Handläufe	3
Handlaufringe für liegende Krümmlinge	4
Handläufe gerade, geschweift	5
Endschnecken	5
Handlauf-Krümmlinge	5
Handlaufstützen	6-7
Übersicht Treppensprossen	8
Treppensprossen	9-22
Treppenfosten	23
Kugeln für Antrittspfosten	24
Treppenrosetten	24
Kropffosten viertelrund	25
Kropffosten halbrund	25
Dralldübel	26
Rundstäbe	27
Leisten	27
Ast- Flickzapfen	27
Allgemeine Verkaufsbedingungen	28

2023

Diverse Drechslerarbeiten offerieren wir Ihnen gerne
Verlangen Sie eine Offerte

**Diverse
Drechslerarbeiten**

Artikel-Nr.	Durchm. mm Ø	Buche ged. .11	Eiche .13	Esche .14	Tanne .31	Ahorn .16	Pfosten gedreht zylindrisch für Tischsäulen usw.
14.008.___	80	101.—	123.—	112.—	101.—	123.—	
14.010.___	100	127.—	163.—	144.—	127.—	163.—	
14.012.___	120	169.—	220.—	195.—	169.—	220.—	
14.014.___	140	210.—	279.—	244.—	210.—	279.—	
14.016.___	160	253.—	343.—	298.—	253.—	343.—	
14.018.___	180	301.—	415.—	357.—	301.—	415.—	
14.020.___	200	355.—	495.—	426.—	355.—	495.—	

Preis per m

- Längen ab 1100 mm bis max. 3500 mm x 25%
- Grössere Durchmesser und Längen auf Anfrage

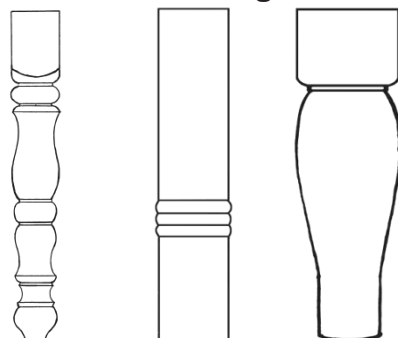
Tischsäulenanfertigungen nach Ihrer Zeichnung Preis auf Anfrage	<p>Tischsäulen gedreht</p>  <p>Beispiele:</p>
--	--

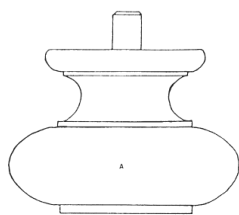
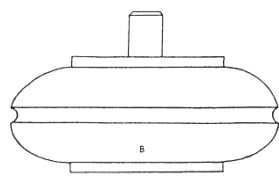
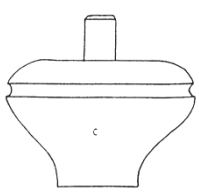
Artikel-Nr.	Durchm. mm Ø	Nussbaum. .19	Tanne .31	Buche .11	Möbelfuss	
60.100.___	100 x 64	41.30	34.70	32.30		
60.120.___	120 x 70	45.80	37.—	34.70		
60.140.___	140 x 74	59.80	46.20	42.70		
Model A						
Artikel-Nr.	Durchm. mm Ø	Nussbaum. .19	Tanne .31	Buche .11	Möbelfuss	
60.101.___	100 x 50	32.50	26.—	24.90		
60.121.___	120 x 60	36.90	28.90	27.70		
60.141.___	140 x 70	50.80	40.40	39.30		
Model B						
Artikel-Nr.	Durchm. mm Ø	Nussbaum. .19	Tanne .31	Buche .11	Möbelfuss	
60.060.___	60 x 44	26.10	22.60	21.30		
60.080.___	80 x 54	33.—	27.70	26.60		
60.102.___	100 x 60	35.60	28.90	27.70		
Model C						

Rabatte: Ab 20 Stück 10% pro Sorte, Grösse und Holzart
Andere Holzarten und Formen auf Anfrage

Artikel-Nr.	Durchm. mm Ø	Buche ged. .11	Eiche .13	Esche .14	Tanne .31	Ahorn .16	Kan. Ahorn .17	
Profil 1 bis 5								
16.040.	40	20.80	32.30	22.90	22.90	28.40	37.50	
16.140.	40	24.95	38.75	27.50	27.50	34.—	45.—	
16.043.	43	24.40	38.—	26.40	26.40	31.50	45.—	
16.143.	43	29.35	45.60	31.70	31.70	37.80	54.—	
16.045.	45	24.40	38.—	26.40	26.40	31.50	45.—	
16.145.	45	29.30	45.60	31.70	31.70	37.80	54.—	
16.050.	50	28.80	44.20	30.80	30.80	39.40	52.50	
16.150.	50	34.55	53.05	36.95	36.95	47.30	63.—	
16.055.	55	31.50	51.50	35.20	35.20	45.70	60.—	
16.155.	55	37.80	61.80	42.25	42.25	54.80	72.—	
Profil F								
16.655.	62/54	29.90	47.80	44.80	29.80	50.20	70.—	
16.656.	62/54	35.90	57.35	53.75	35.75	60.20	84.—	
Profil E								
16.538.	54/38	20.50	37.80	34.20	20.50	37.—		
16.539.	54/38	24.60	45.35	41.05	24.60	44.40		
<p>16.0 -- , Ziffer 0 = Handläufe bis 3000 mm Länge 16.1 -- , Ziffer 1 = Handläufe über 3000 mm Länge Je nach Holzqualität und -länge kann der Handlauf gezinkte Stösse Aufweisen</p> <p>Grössere Mengen auf Anfrage</p>								

Artikel-Nr.	Weitere Ausführung	Preis
16.089.00	Handlauf Profil E + F Enden runden	26.30 / Stck.
16.090.00	Handlauf Profil D40-55 Enden runden	10.- / Stck.
16.190.00	Winkelschnitte leicht gefast	9.- / Stck.
16.092.00	Handlauf Nut einfräsen bis 30 x 10 mm	9.20/ lm
16.093.00	Zuschlag für Nut ausfahren	8.80 / Stck.
16.094.00	Profil D40-55 Fläche abgekehlt	8.- / lm
16.095.00	Gehrungs-Zusammenbau	50.- / Stck.
16.096.00	Zusammenbau Handlauf gerade	30.- / Stck.
16.097.00	Bohrungen für Handlaufstützen	6.- / Stck.
	Lackierzuschlag 2 x DD-Lack mit Zwischenschliff	
16.999.00	bis 10 lm	12.- p/m
16.999.10	ab 10 lm	8.50 pm
16.888.00	2 x ölen mit Zwischenschliff	14.- p/m
Bohrung auf Anfrage		

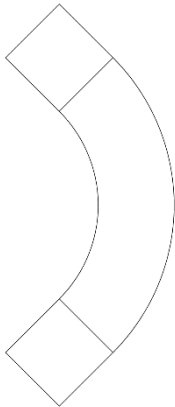
Artikel-Nr.	Profil	Holzart.	Grösse mm Aussen Ø	-90°	
16.240.11	Ø 40	Buche	200	83.65	<p>liegende Krümmlinge bis 90°</p> 
16.240.13	Ø 40	Eiche	200	91.10	
16.240.14	Ø 40	Esche	200	88.80	
16.245.11	Ø 45	Buche	200	96.10	
16.245.13	Ø 45	Eiche	200	106.20	
16.245.14	Ø 45	Esche	200	104.05	
16.250.11	Ø 50+55	Buche	200	127.25	
16.250.13	Ø 50+55	Eiche	200	136.30	
16.250.14	Ø 50+55	Esche	200	133.45	
16.238.11	«E» 54x38	Buche	200	86.15	
16.238.13	«E» 54x38	Eiche	200	95.30	
16.238.14	«E» 54x38	Esche	200	90.70	
16.254.11	«F» 54x62	Buche	200	98.30	
16.254.13	«F» 54x62	Eiche	200	110.40	
16.254.14	«F» 54x62	Esche	200	104.30	

Artikel-Nr.	Typ	Buche ged. .11	Eiche .13	Esche .14	Handläufe gerade, geschweift 
16.940. __	Ø 40mm	210.-	242.40	232.80	
16.945. __	Ø 45mm	217.20	254.40	243.60	
16.950. __	Ø 50+55mm	223.20	278.40	265.20	
16.954. __	Profil F (62/54mm)	232.80	265.20	255.60	
16.938. __	Profil E (54/38mm)	217.20	254.40	243.60	

Durchbiegung: auf 1m max. 10cm
auf 2m max. 20cm
auf 3m max. 30cm

Artikel-Nr.	Profil	Buche ged. .11	Eiche .13	Ahorn/Esche .16/.14	Tanne .31	Endschnecken
16.940. __	F	210.-	230.-	225.-	240.-	
16.945. __	E	180.-	195.-	190.-	205.-	

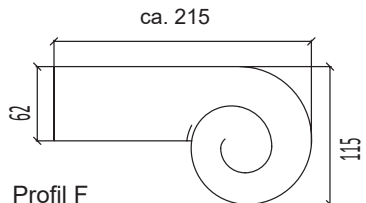

ca. 215

62

115

Profil F

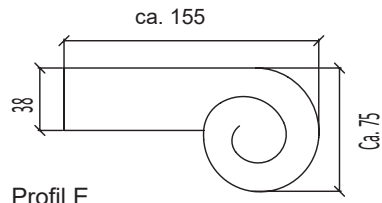

ca. 155

38

Ca. 75

Profil E

Am Handlauf angesetzte Endschnecken erhalten einen Zuschlag von Fr. 30.-

Handlaufkrümmlinge, schichtverleimte Handlaufteile, Treppenwangen sowie Treppentritte offerieren wir Ihnen gerne.

Fragen Sie uns an.

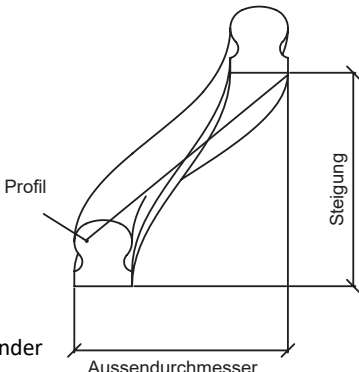

Profil F
für Sprossengeländer

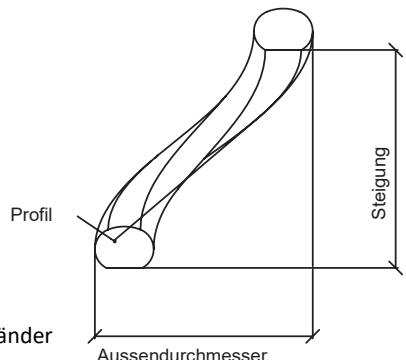



Profil E
für Eisengeländer

Handlauf - Krümmlinge

Artikel-Nr.	Oberfläche	Grösse	Stückpreis	Handlaufstützen 
97.601.0060.02	Verzinkt	60mm	10.80	
97.601.0075.02	Verzinkt	75mm	12.20	
97.601.0060.03	Verchromt	60mm	22.45	
97.601.0060.05	Inox matt	60mm	25.25	
97.601.0075.05	Inox matt	75mm	28.55	
97.601.0060.10	We iss	60mm	20.35	
97.601.0060.11	Schwarz	60mm	20.35	
97.604.0060.02	Verzinkt	60mm	13.3	
97.604.0075.02	Verzinkt	75mm	15.-	
97.604.0060.05	Inox matt	60mm	27.20	
97.604.0075.05	Inox matt	75mm	30.40	
97.581.6075.02	Verzinkt	60 – 75mm	16.45	
97.581.6075.05	Inox matt	60 – 75mm	47.60	
97.584.6075.02	Verzinkt	60 – 75mm	19.05	
97.584.6075.05	Inox matt	60 – 75mm	48.70	
97.601.0060.06	Inox matt	60mm	34.55	
97.601.0075.06	Inox matt	75mm	36.-	
97.604.0060.06	Inox matt	60mm	37.45	
97.604.0075.06	Inox matt	75mm	39.15	
97.579.4060.02	Verzinkt	60-75mm D40mm	23.05	
97.579.4560.02	Verzinkt	60-75mm D45mm	23.05	
97.579.4060.05	Inox matt	60-75mm D40mm	52.35	
97.579.4560.05	Inox matt	60-75mm D45mm	52.35	

Die aufgeführten Stützen sind zum Teil lagerhaltig.

Mengenrabatte: auf Anfrage

Artikel-Nr.	Oberfläche	Grösse	Stückpreis	Handlaufstützen
97.602.4075.02	Verzinkt	75mm D40mm	17.10	
97.602.4575.02	Verzinkt	75mm D45mm	17.10	
97.602.4075.05	Inox matt	75mm D40mm	31.70	
97.602.4575.05	Inox matt	75mm D45mm	31.70	
				
97.602.4075.06	Inox matt	75mm D40mm	41.25	
				
97.02087.75.05	Inox matt	75mm	39.90	
<p>Die aufgeführten Stützen sind zum Teil lagerhaltig. Mengenrabatte: auf Anfrage</p>				

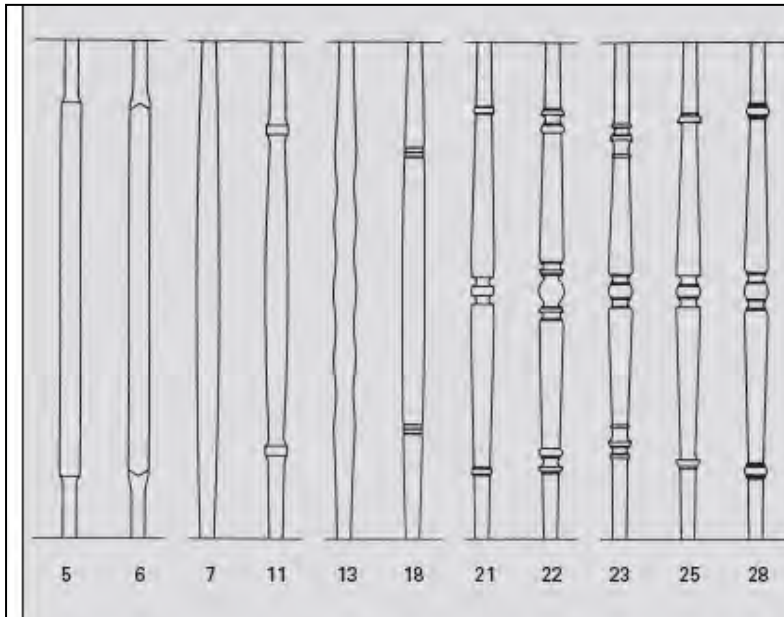

Treppensprossen BM

Zeichnungen von TM Sprossen sind im separaten Katalog

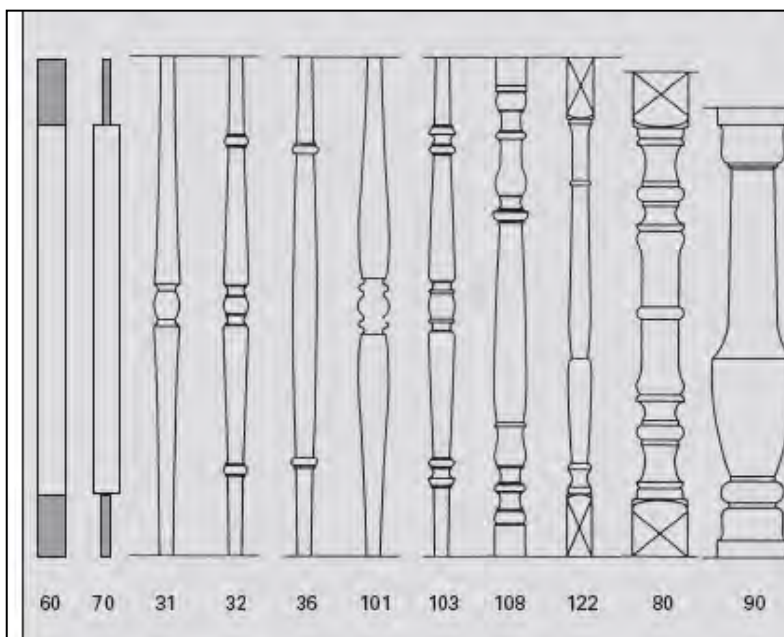



Sprossen lackieren



Lackierzuschlag 2x DD-Lack mit Zwischenschliff



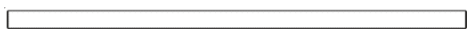

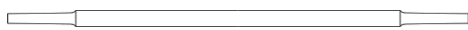
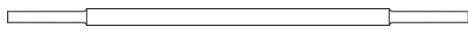
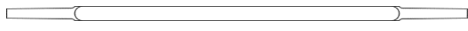
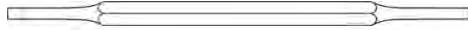



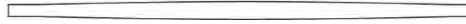











Nr. 1-18 5.20p/Stk.





Nr. 21-122 5.90p/Stk.









Wir drehen Sprossen und Baluster auch nach ihrem Muster oder Plan!







Artikel-Nr.	Sprossen Name / Bez.	Länge mm max. Ømm	Buche ged. .11	Eiche .13	Esche .14	Tanne .31	Ahorn .16	Treppensprossen	
								roh, geschliffen Zapfenende Ø 20mm	
18.001. __	Ø20	1000 Ø20	5.30	7.95	5.90	5.90	7.40	Treppensprossen zylindrisch	
18.002. __	Ø25	1000 Ø25	7.30	10.90	8.30	8.30	9.80		
18.003. __	Ø30	1000 Ø30	9.90	15.80	11.70	11.70	14.10		
18.005. __	BM 5	750/Ø34	15.35	18.60	15.35	18.80	18.60	BM 5	
17.005. __	TM 5	750/Ø30							
18.105. __	BM 5	800mm	16.05	19.45	16.05	19.70	18.15		
17.105. __	TM 5								
18.205. __	BM 5	850mm	16.85	20.45	16.90	20.65	19.10	TM 5	
17.205. __	TM 5								
18.305. __	BM 5	900mm	18.00	21.80	18.00	22.05	20.35		
17.305. __	TM 5								
18.405. __	BM 5	950mm	19.20	23.25	19.20	23.50	21.70		
17.405. __	TM 5								
18.505. __	BM 5	1000mm	20.55	24.90	20.60	25.20	23.35		
17.505. __	TM 5								
18.006. __	BM 6	750/[]25+30	25.30	28.30	26.50	27.60	28.30	BM 6	
17.060. __	TM 60								
18.106. __	BM 6	800mm	25.80	29.30	27.40	28.30	29.30		
17.160. __	TM 60								
18.206. __	BM 6	850mm	27.30	31.30	29.00	29.80	31.30	TM 60	
17.260. __	TM 60								
18.306. __	BM 6	900mm	28.50	32.70	30.30	31.00	32.70		
17.360. __	TM 60								
18.406. __	BM 6	950mm	29.80	34.20	31.80	32.50	34.20		
17.460. __	TM 60								
18.506. __	BM 6	1000mm	31.00	35.80	33.30	34.00	35.70		
17.560. __	TM 60								





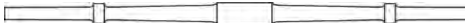

Artikel-Nr.	Sprossen Name / Bez.	Länge mm max. Ømm	Buche ged.	Eiche	Esche	Tanne	Ahorn	Treppensprossen roh, geschliffen Zapfenende Ø 20mm
			.11	.13	.14	.31	.16	
18.007. __	BM 7	750/Ø34	14.40	17.45	14.80	16.35	16.35	BM 7 
18.013. __	BM 13	750/Ø33						
17.009. __	TM 9	750/Ø35						
	TM 10	750/Ø30						
18.107. __	BM 7	800mm	15.35	18.25	15.50	17.15	17.10	BM 13 
18.113. __	BM 13							
17.109. __	TM 9							
	TM 10							
18.207. __	BM 7	850mm	16.15	19.15	16.30	18.00	17.95	TM 9 
18.213. __	BM 13							
17.209. __	TM 9							
	TM 10							
18.307. __	BM 7	900mm	17.20	20.45	17.35	19.20	19.15	TM 10 
18.313. __	BM 13							
17.309. __	TM 9							
	TM 10							
18.407. __	BM 7	950mm	18.35	21.80	18.55	20.50	20.45	
18.413. __	BM 13							
17.409. __	TM 9							
	TM 10							
18.507. __	BM 7	1000mm	19.65	23.35	19.85	21.95	21.90	
18.513. __	BM 13							
17.509. __	TM 9							
	TM 10							



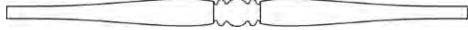



Artikel-Nr.	Sprossen Name / Bez.	Länge mm	Buche ged.	Eiche	Esche	Tanne	Ahorn	Treppensprossen roh, geschliffen Zapfenende Ø 20mm
		max. Ømm	.11	.13	.14	.31	.16	
18.011. __	BM 11	750/Ø34	16.90	20.25	16.90	20.65	18.95	BM 11
18.018. __	BM 18							
18.036. __	BM 36							
17.007. __	TM 7	750/Ø31						
	TM 11	750/Ø32						
	TM 12	750/Ø35						
	TM 13	750/Ø32						
	TM 14	750/Ø35						
18.111. __	BM 11	800mm	17.70	21.20	17.70	21.60	19.85	BM 36
18.118. __	BM 18							
18.136. __	BM 36							
17.107. __	TM 7							
	TM 11							
	TM 12							
	TM 13							
	TM 14							
18.211. __	BM 11	850mm	18.60	22.25	18.60	22.70	20.85	TM 11
18.218. __	BM 18							
18.236. __	BM 36							
17.207. __	TM 7							
	TM 11							
	TM 12							
	TM 13							
	TM 14							
18.311. __	BM 11	900mm	19.80	23.75	19.85	24.20	22.25	TM 13
18.318. __	BM 18							
18.336. __	BM 36							
17.307. __	TM 7							
	TM 11							
	TM 12							
	TM 13							
	TM 14							
18.411. __	BM 11	950mm	21.15	25.35	21.15	25.80	23.70	TM 13
18.418. __	BM 18							
18.436. __	BM 36							
17.407. __	TM 7							
	TM 11							
	TM 12							
	TM 13							
	TM 14							
18.511. __	BM 11	1000mm	22.65	27.15	22.65	27.65	25.40	TM 13
18.518. __	BM 18							
18.536. __	BM 36							
17.507. __	TM 7							
	TM 11							
	TM 12							
	TM 13							
	TM 14							









Artikel-Nr.	Sprossen Name / Bez.	Länge mm max. Ømm	Treppensprossen					roh, geschliffen Zapfenende Ø 20mm
			Buche ged. .11	Eiche .13	Esche .14	Tanne .31	Ahorn .16	
18.021. __	BM 21	750/Ø33	19.80	24.00	20.00	26.45	21.70	BM 21 
18.025. __	BM 25	750/Ø37						
18.028. __	BM 28	750/Ø38						
18.032. __	BM 32	750/Ø38						
17.035. __	TM 35	750/Ø35						
18.121. __	BM 21	800mm	20.70	25.15	20.95	27.65	22.75	BM 25 
18.125. __	BM 25							
18.128. __	BM 28							
18.132. __	BM 32							
17.135. __	TM 35							
18.221. __	BM 21	850mm	21.75	26.40	22.00	29.05	23.85	BM 28 
18.225. __	BM 25							
18.228. __	BM 28							
18.232. __	BM 32							
17.235. __	TM 35							
18.321. __	BM 21	900mm	23.20	28.20	23.45	31.00	25.45	BM 32 
18.325. __	BM 25							
18.328. __	BM 28							
18.332. __	BM 32							
17.335. __	TM 35							
18.421. __	BM 21	950mm	24.75	30.05	25.05	33.05	27.15	TM 35 
18.425. __	BM 25							
18.428. __	BM 28							
18.432. __	BM 32							
17.435. __	TM 35							
18.521. __	BM 21	1000mm	26.50	32.15	26.80	35.40	29.10	
18.525. __	BM 25							
18.528. __	BM 28							
18.532. __	BM 32							
17.535. __	TM 35							







Artikel-Nr.	Sprossen Name / Bez.	Länge mm max. Ømm	Buche ged. .11	Eiche .13	Esche .14	Tanne .31	Ahorn .16	Treppensprossen roh, geschliffen Zapfenende Ø 20mm
18.022. __	BM 22	750/Ø38	22.00	27.30	22.20	30.90	24.20	BM 22 
18.0103. __	BM 103							
17.042. __	TM 42							
	TM 43	750/Ø38						
	TM 44	750/Ø40						
								BM 103 
18.122. __	BM 22	800mm	23.05	28.55	23.25	32.35	25.35	TM 42 
18.1103. __	BM 103							
17.142. __	TM 42							
	TM 43							
	TM 44							
								TM 43 
18.222. __	BM 22	850mm	24.20	30.00	24.40	33.95	26.60	TM 43 
18.2103. __	BM 103							
17.242. __	TM 42							
	TM 43							
	TM 44							
								TM 44 
18.322. __	BM 22	900mm	25.80	32.00	26.05	36.20	28.40	TM 44 
18.3103. __	BM 103							
17.342. __	TM 42							
	TM 43							
	TM 44							
								TM 44 
18.422. __	BM 22	950mm	27.55	34.15	27.80	38.65	30.30	
18.4103. __	BM 103							
17.442. __	TM 42							
	TM 43							
	TM 44							
18.522. __	BM 22	1000mm	29.50	36.60	29.75	41.40	32.45	
18.5103. __	BM 103							
17.542. __	TM 42							
	TM 43							
	TM 44							

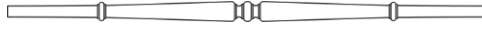
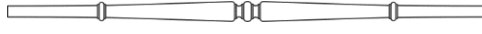
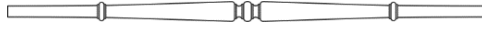





Artikel-Nr.	Sprossen Name / Bez.	Länge mm max. Ømm	Treppensprossen					roh, geschliffen Zapfenende Ø 20mm	
			Buche ged. .11	Eiche .13	Esche .14	Tanne .31	Ahorn .16		
18.023. __	BM 23	750/Ø34	19.75	24.10	19.95	28.85	21.70	BM 23 	
17.033. __	TM 33	750/Ø35							
18.123. __	BM 23	800mm	20.65	25.25	20.90	30.20	22.70		
17.133. __	TM 33								
18.223. __	BM 23	850mm	21.70	26.50	21.95	31.70	23.85		TM 33 
17.233. __	TM 33								
18.323. __	BM 23	900mm	23.15	28.30	23.40	33.85	25.45		
17.333. __	TM 33								
18.423. __	BM 23	950mm	24.70	30.20	24.95	36.10	27.15		
17.433. __	TM 33								
18.523. __	BM 23	1000mm	26.45	32.35	26.75	38.65	29.10		
17.533. __	TM 33								
18.031. __	BM 31	750/Ø38	18.40	23.00	18.60	23.00	20.45	BM 31 	
17.026. __	TM 26	750/Ø35							
	TM 27	750/Ø49							
	TM 28	750/Ø40							
	TM 28a								
	TM 29	750/Ø30							
18.131. __	BM 31	800mm	19.25	24.05	19.50	24.10	21.40		TM 26 
17.126. __	TM 26								
	TM 27								
	TM 28								
	TM 28a								
18.231. __	BM 31	850mm	20.25	25.25	20.45	25.30	22.45	TM 27 	
17.226. __	TM 26								
	TM 27								
	TM 28								
	TM 28a								
18.331. __	BM 31	900mm	21.55	26.95	21.85	26.95	23.95		TM 28 
17.326. __	TM 26								
	TM 27								
	TM 28								
	TM 28a								
18.431. __	BM 31	950mm	23.00	28.75	23.30	28.75	25.55	TM 28a 	
17.426. __	TM 26								
	TM 27								
	TM 28								
	TM 28a								
18.531. __	BM 31	1000mm	24.65	30.80	24.95	30.80	27.40		TM 29 
17.526. __	TM 26								
	TM 27								
	TM 28								
	TM 28a								
	TM 29								



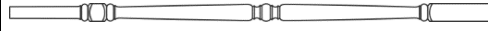

Artikel-Nr.	Sprossen Name / Bez.	Länge mm max. Ømm	Buche ged. .11	Eiche .13	Esche .14	Tanne .31	Ahorn .16	Treppensprossen roh, geschliffen Zapfenende Ø 20mm
18.0101.____	BM 101	750/Ø46	23.30	29.35	23.35	32.25	25.65	BM 101 
17.048.____	TM 48	750/Ø44						TM 48 
	TM 50	750/Ø43						
	TM 52	750/Ø53						
	TM 53	750/Ø45						
	TM 57	750/Ø43						
	TM 59	750/Ø53						
18.1101.____	BM 101	800mm	24.40	30.75	24.45	33.80	26.85	TM 50 
17.148.____	TM 48							
	TM 52							
	TM 53							
	TM 57							
	TM 59							
18.2101.____	BM 101	850mm	25.60	32.25	25.65	35.45	28.20	TM 53 
17.248.____	TM 48							
	TM 50							
	TM 52							
	TM 53							
	TM 57							
18.3101.____	BM 101	900mm	27.30	34.40	27.35	37.85	30.05	TM 57 
17.348.____	TM 48							
	TM 50							
	TM 52							
	TM 53							
	TM 59							
18.4101.____	BM 101	950mm	29.15	36.75	29.20	40.35	32.10	TM 59 
17.448.____	TM 48							
	TM 50							
	TM 52							
	TM 53							
	TM 57							
18.5101.____	BM 101	1000mm	31.20	39.35	31.25	43.25	34.35	
17.548.____	TM 48							
	TM 50							
	TM 52							
	TM 53							
	TM 57							















Artikel-Nr.	Sprossen Name / Bez.	Länge mm max. Ømm	Buche ged. .11	Eiche .13	Esche .14	Tanne .31	Ahorn .16	Treppensprossen
								roh, geschliffen Zapfenende Ø 20mm
17.015. __	TM 15	750/Ø35	20.20	24.60	20.45	27.75	22.20	TM 15 
	TM 16							
	TM 17							
	TM 18							
17.115. __	TM 15	800mm	21.15	25.75	21.40	29.05	23.20	TM 16 
	TM 16							
	TM 17							
	TM 18							
17.215. __	TM 15	850mm	22.20	27.05	22.45	30.50	24.40	TM 17 
	TM 16							
	TM 17							
	TM 18							
17.315. __	TM 15	900mm	23.70	28.85	23.95	32.50	26.00	TM 18 
	TM 16							
	TM 17							
	TM 18							
17.415. __	TM 15	950mm	25.30	30.80	25.55	34.70	27.75	
	TM 16							
	TM 17							
	TM 18							
17.515. __	TM 15	1000mm	27.10	32.95	27.40	37.15	29.70	
	TM 16							
	TM 17							
	TM 18							
17.019. __	TM 19	750/Ø35	18.90	22.60	19.30	22.75	20.70	TM 19 
17.119. __	TM 19	800mm	19.80	23.65	20.20	23.80	21.70	
17.219. __	TM 19	850mm	20.80	24.85	21.20	25.00	22.75	
17.319. __	TM 19	900mm	22.15	26.50	22.60	26.65	24.30	
17.419. __	TM 19	950mm	23.65	28.25	24.15	28.45	25.90	
17.519. __	TM 19	1000mm	25.35	30.25	25.85	30.50	27.75	
17.020. __	TM 20	750/Ø35	19.80	23.45	20.00	26.45	21.70	
	TM 21							
	TM 24							
17.120. __	TM 20	800mm	20.70	24.60	20.95	27.65	22.75	TM 21 
	TM 21							
	TM 24							
17.220. __	TM 20	850mm	21.75	25.80	22.00	29.05	23.85	TM 24 
	TM 21							
	TM 24							
17.320. __	TM 20	900mm	23.20	27.55	23.45	31.00	25.45	
	TM 21							
	TM 24							
17.420. __	TM 20	950mm	24.75	29.35	25.05	33.05	27.15	
	TM 21							
	TM 24							
17.520. __	TM 20	1000mm	26.50	31.45	26.80	35.40	29.10	
	TM 21							
	TM 24							







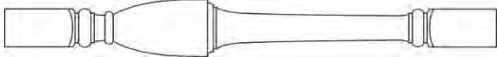
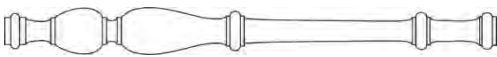

Artikel-Nr.	Sprossen Name / Bez.	Länge mm max. Ømm	Treppensprossen					roh, geschliffen Zapfenende Ø 20mm
			Buche ged. .11	Eiche .13	Esche .14	Tanne .31	Ahorn .16	
17.022. __	TM 22	750/Ø35	20.20	24.60	20.45	29.30	22.20	TM 22 
	TM 23							
	TM 25							
17.122. __	TM 22	800mm	21.15	25.75	21.40	30.70	23.20	TM 23 
	TM 23							
	TM 25							
17.222. __	TM 22	850mm	22.20	27.05	22.45	32.25	24.40	TM 25 
	TM 23							
	TM 25							
17.322. __	TM 22	900mm	23.70	28.85	23.95	34.40	26.00	
	TM 23							
	TM 25							
17.422. __	TM 22	950mm	25.30	30.80	25.55	36.70	27.75	
	TM 23							
	TM 25							
17.522. __	TM 22	1000mm	27.10	32.95	27.40	39.30	29.70	
	TM 23							
	TM 25							
17.030. __	TM 30	750/Ø35	19.15	23.55	19.40	27.50	21.15	TM 30 
	TM 31	750/Ø34						
	TM 32	750/Ø38						
	TM 34	750/Ø35						
17.130. __	TM 30	800mm	20.05	24.65	20.30	28.80	22.10	TM 31 
	TM 31							
	TM 32							
	TM 34							
17.230. __	TM 30	850mm	21.05	25.90	21.30	30.25	23.25	TM 32 
	TM 31							
	TM 32							
	TM 34							
17.330. __	TM 30	900mm	22.45	27.60	22.75	32.25	24.80	TM 34 
	TM 31							
	TM 32							
	TM 34							
17.430. __	TM 30	950mm	23.95	29.45	24.25	34.40	26.45	
	TM 31							
	TM 32							
	TM 34							
17.530. __	TM 30	1000mm	25.65	31.55	25.95	36.85	28.30	
	TM 31							
	TM 32							
	TM 34							

Artikel-Nr.	Sprossen Name / Bez.	Länge mm max. Ømm	Treppensprossen					roh, geschliffen Zapfenende Ø 20mm
			Buche ged. .11	Eiche .13	Esche .14	Tanne .31	Ahorn .16	
17.036. __	TM 36	750/Ø35	19.85	24.05	20.05	27.80	21.75	TM 36 
17.136. __	TM 36	800mm	20.75	25.20	21.00	29.10	22.80	
17.236. __	TM 36	850mm	21.80	26.45	22.05	30.55	23.95	
17.336. __	TM 36	900mm	23.25	28.20	23.55	32.60	25.50	
17.436. __	TM 36	950mm	24.80	30.10	25.10	34.75	27.25	
17.536. __	TM 36	1000mm	26.60	32.25	26.90	37.25	29.15	
17.039. __	TM 39	750/Ø35	19.40	23.45	19.65	25.35	21.30	TM 39 
17.139. __	TM 39	800mm	20.30	24.60	20.55	26.55	22.30	
17.239. __	TM 39	850mm	21.35	25.80	21.60	27.85	23.40	
17.339. __	TM 39	900mm	22.75	27.55	23.00	29.70	24.95	
17.439. __	TM 39	950mm	24.30	29.35	24.55	31.70	26.65	
17.539. __	TM 39	1000mm	26.00	31.45	26.30	33.95	28.55	
17.040. __	TM 40 TM 41	750/Ø40	19.30	24.35	19.15	26.65	21.40	TM 40 
17.140. __	TM 40 TM 41	800mm	20.20	25.50	20.40	28.30	22.45	
17.240. __	TM 40 TM 41	850mm	21.20	26.80	21.45	29.30	23.55	TM 41 
17.340. __	TM 40 TM 41	900mm	22.60	28.55	22.85	31.70	25.10	
17.440. __	TM 40 TM 41	950mm	24.15	30.50	24.40	33.85	26.80	
17.540. __	TM 40 TM 41	1000mm	25.85	32.65	26.15	36.25	28.70	
17.045. __	TM 45 TM 46 TM 47	750/Ø38 750/Ø40	21.55	23.60	21.75	29.30	23.65	TM 45 
17.145. __	TM 45 TM 46 TM 47	800mm	22.55	24.85	22.75	30.65	24.80	
17.245. __	TM 45 TM 46 TM 47	850mm	23.65	26.25	23.90	32.20	26.00	
17.345. __	TM 45 TM 46 TM 47	900mm	25.25	28.20	25.50	34.35	27.75	TM 46 
17.445. __	TM 45 TM 46 TM 47	950mm	26.95	30.30	27.20	36.65	29.60	
17.545. __	TM 45 TM 46 TM 47	1000mm	28.85	32.65	29.15	39.25	31.70	

Artikel-Nr.	Sprossen Name / Bez.	Länge mm max. Ømm	Buche ged. .11	Eiche .13	Esche .14	Tanne .31	Ahorn .16	Treppensprossen	
								roh, geschliffen Zapfenende Ø 20mm	
17.049. __	TM 49	750/Ø40	23.10	28.05	23.35	32.85	25.45	TM 49 	
17.149. __	TM 49	800mm	24.20	29.40	24.45	34.40	26.65		
17.249. __	TM 49	850mm	25.40	30.85	25.65	36.15	28.00		
17.349. __	TM 49	900mm	27.10	32.95	27.35	38.55	29.85		
17.449. __	TM 49	950mm	28.95	35.15	29.20	41.15	31.90		
17.549. __	TM 49	1000mm	31.00	37.65	31.30	44.05	34.15		
17.051. __	TM 51	750/Ø43	20.80	26.45	20.80	29.05	23.00	TM 51 	
17.151. __	TM 51	800mm	21.75	27.70	21.80	30.40	24.10		
17.251. __	TM 51	850mm	22.85	29.05	22.90	31.95	25.30		
17.351. __	TM 51	900mm	24.35	31.00	24.40	34.05	27.00		
17.451. __	TM 51	950mm	26.00	33.10	26.05	36.35	28.80		
17.551. __	TM 51	1000mm	27.85	35.45	27.90	38.90	30.85		
17.061. __	TM 61	750/[]35	23.15	26.50	23.15	30.05	24.95	TM 61 	
	TM 62	750/[]30							
	TM 65	750/Ø34/[]35							
	TM 66								
	TM 69								750/Ø34/[]36
17.161. __	TM 61	800mm	24.25	27.75	24.20	31.45	26.10	TM 62 	
	TM 62								
	TM 65								
	TM 66								
	TM 69								
17.261. __	TM 61	850mm	25.45	29.15	25.45	33.00	27.40	TM 65 	
	TM 62								
	TM 65								
	TM 66								
	TM 69								
17.361. __	TM 61	900mm	27.15	31.05	27.15	35.20	29.25	TM 66 	
	TM 62								
	TM 65								
	TM 66								
	TM 69								
17.461. __	TM 61	950mm	29.00	33.15	28.95	37.55	31.20	TM 69 	
	TM 62								
	TM 65								
	TM 66								
	TM 69								
17.561. __	TM 61	1000mm	31.05	35.50	31.00	40.25	33.40		
	TM 62								
	TM 65								
	TM 66								
	TM 69								

Artikel-Nr.	Sprossen Name / Bez.	Länge mm max. Ømm	Buche	Eiche	Esche	Tanne	Ahorn	Treppensprossen roh, geschliffen Zapfenende Ø 20mm
			ged. .11	.13	.14	.31	.16	
17.064. __	TM 64	750/35[]	22.90	26.15	22.90	29.00	24.65	TM 64
17.164. __	TM 64	800mm	23.95	27.40	23.95	30.35	25.80	
17.264. __	TM 64	850mm	25.15	28.75	25.15	31.85	27.10	
17.364. __	TM 64	900mm	26.85	30.70	26.85	34.00	28.90	
17.464. __	TM 64	950mm	28.65	32.75	28.65	36.25	30.80	
17.564. __	TM 64	1000mm	30.70	35.05	30.70	38.85	33.00	
17.067. __	TM 67	750/Ø45/[]36	29.40	35.80	28.95	36.35	32.25	TM 67 
	TM 75	750/Ø53/[]42						
	TM 76	750/Ø45/[]42						
	TM 78	750/Ø48/[]42						
17.167. __	TM 67	800mm	30.75	37.50	30.30	38.05	33.75	TM 75 
	TM 75							
	TM 76							
	TM 78							
17.267. __	TM 67	850mm	32.30	39.35	31.80	39.95	35.45	TM 76 
	TM 75							
	TM 76							
	TM 78							
17.367. __	TM 67	900mm	34.45	42.00	33.95	42.60	37.80	TM 78 
	TM 75							
	TM 76							
	TM 78							
17.467. __	TM 67	950mm	36.75	44.80	36.20	45.45	40.35	
	TM 75							
	TM 76							
	TM 78							
17.567. __	TM 67	1000mm	39.40	48.00	38.75	48.70	43.20	
	TM 75							
	TM 76							
	TM 78							

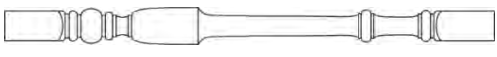
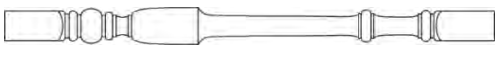
Artikel-Nr.	Sprossen Name / Bez.	Länge mm max. Ømm	Buche	Eiche	Esche	Tanne	Ahorn	Treppensprossen roh, geschliffen Zapfenende Ø 20mm
			ged. .11	.13	.14	.31	.16	
17.070.____	TM 70	750/Ø37/[]40	25.80	30.75	25.60	33.25	27.80	TM 70 
	TM 71	750/Ø39/[]40						TM 71 
	TM 72							TM 72 
	TM 73							
	TM 74							TM 74 
	TM 77	TM 77 						
17.170.____	TM 70	800mm	27.00	32.20	26.80	34.80	29.15	TM 73 
	TM 71							TM 74 
	TM 72							
	TM 73							
	TM 74							
	TM 77							
17.270.____	TM 70	850mm	28.35	33.85	28.15	36.55	30.60	TM 70 
	TM 71							TM 71 
	TM 72							
	TM 73							
	TM 74							
	TM 77							
17.370.____	TM 70	900mm	30.25	36.10	30.05	39.00	32.65	TM 73 
	TM 71							TM 74 
	TM 72							
	TM 73							
	TM 74							
	TM 77							
17.470.____	TM 70	950mm	32.25	38.50	32.05	41.60	34.80	TM 70 
	TM 71							TM 71 
	TM 72							
	TM 73							
	TM 74							
	TM 77							
17.570.____	TM 70	1000mm	34.55	41.25	34.30	44.50	37.30	TM 73 
	TM 71							TM 74 
	TM 72							
	TM 73							
	TM 74							
	TM 77							

Artikel-Nr.	Sprossen Name / Bez.	Länge mm max. []mm	Buche	Eiche	Esche	Tanne	Ahorn	Treppensprossen roh, geschliffen Zapfenende Ø 20mm
			ged. .11	.13	.14	.31	.16	
17.080. __	TM 80	750/[]60	48.45	65.80	49.05	57.80	55.10	TM 80 
	TM 85	750mm						
	TM 87	750/[]72						
17.180. __	TM 80	800mm	50.75	68.90	51.40	60.50	57.70	TM 85 
	TM 85							
	TM 87							
17.280. __	TM 80	850mm	53.25	72.35	53.95	63.55	60.60	TM 87 
	TM 85							
	TM 87							
17.380. __	TM 80	900mm	56.80	77.20	57.55	67.80	64.65	
	TM 85							
	TM 87							
17.480. __	TM 80	950mm	60.60	82.35	61.40	72.30	68.95	
	TM 85							
	TM 87							
17.580. __	TM 80	1000mm	64.95	88.20	65.75	77.45	73.85	
	TM 85							
	TM 87							
17.081. __	TM 81	750/[]64	39.30	47.95	38.90	48.50	42.70	TM 81 
	TM 82							
	TM 84	750/[]52						
17.181. __	TM 81	800mm	41.15	50.20	40.75	50.80	44.70	TM 82 
	TM 82							
	TM 84							
17.281. __	TM 81	850mm	43.20	52.70	42.80	53.35	46.95	TM 84 
	TM 82							
	TM 84							
17.381. __	TM 81	900mm	46.10	56.25	45.65	56.90	50.10	
	TM 82							
	TM 84							
17.481. __	TM 81	950mm	49.15	60.00	48.70	60.70	53.45	
	TM 82							
	TM 84							
17.581. __	TM 81	1000mm	52.65	64.25	52.15	65.00	57.25	
	TM 82							
	TM 84							

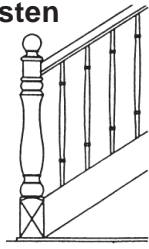
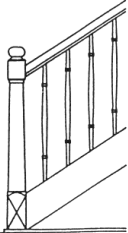
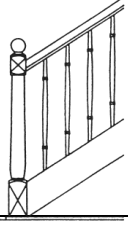
Artikel-Nr.	Holzart	Masse	Stückpreis Fr.	Antrittspfosten Gedreht, ohne Handlaufanschluss Länge 1400mm geschliffen 
14.001.11	Buche ged.	140 x 140 mm	500.—	
14.001.13/.14	Eiche/Esche	140 x 140 mm	648.—	
14.001.31	Tanne	140 x 140 mm	500.—	
				
14.004.11	Buche ged.	120 x 120 mm	325.—	
14.004.13/.14	Eiche/Esche	120 x 120 mm	416.—	
14.004.31	Tanne	120 x 120 mm	325.—	
14.009.11	Buche ged.	120 x 120 mm	367.—	
14.009.13/.14	Eiche/Esche	120 x 120 mm	440.—	
14.009.31	Tanne	120 x 120 mm	367.—	

Die Modelle 14.001. und 14.004. können auch mit einem vierkantigen Handlaufanschluss geliefert werden.
Aufpreis 45.00

Andere Modelle offerieren wir Ihnen gerne nach Ihrer Skizze

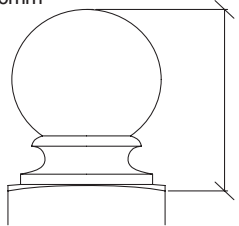
Artikel-Nr.	Grösse mm	Buche ged. .11	Eiche .13	Esche .14	Tanne .31	Ahorn .16	Treppenhpfosten Vierkant mit angedrehter Kugel Totallänge 1400mm 
14.005.__	80/ 80	197.-	232.-	208.-	198.-	232.-	
14.006.__	100/100	225.-	277.-	253.-	242.-	290.-	
14.007.__	120/120	264.-	352.-	290.-	270.-	352.-	
14.026.__	140/140	300.-	415.-	342.-	308.-	415.-	

A = 107 mm bei 80/ 80
 A = 125 mm bei 100/100
 A = 160 mm bei 120/120
 A = 170 mm bei 140/140

Artikel-Nr.	Grösse mm	Buche ged. .11	Eiche .13	Esche .14	Tanne .31	Ahorn .16	Treppenhpfosten Vierkant mit Pyramidenschnitt Totallänge 1400mm 
13.060.__	60/60	57.15	83.40	60.15	58.65	67.65	
13.080.__	80/80	87.60	137.60	93.30	90.45	107.60	
13.100.__	100/100	101.90	176.85	110.45	106.15	131.85	
13.120.__	120/120	127.45	232.40	139.45	133.45	169.45	
13.140.__	140/140	157.45	314.90	175.45	166.45	220.40	

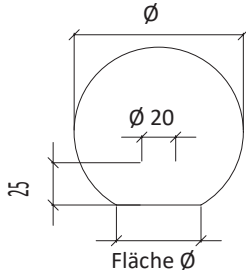
Artikel-Nr.	Grösse mm	Buche ged. .11	Eiche .13	Esche .14	Tanne .31	Ahorn .16	Kugel für Antrittspfosten sauber geschliffen 20mm Dübel beiliegend 
14.040. _ _	Ø 50 mm	7.50	10.70	9.10	7.50	10.70	
14.041. _ _	Ø 60 mm	7.50	10.70	9.10	7.50	10.70	
14.042. _ _	Ø 70 mm	16.80	22.80	18.90	15.50	22.80	
14.043. _ _	Ø 80 mm	16.80	22.80	18.90	15.50	22.30	
14.044. _ _	Ø 90 mm	23.70	34.30	28.90	22.30	34.30	
14.045. _ _	Ø 100 mm	23.70	34.30	28.90	22.30	34.30	
14.046. _ _	Ø 120 mm	40.90	49.—	45.—	39.50	49.—	

Ø der Fläche bei Ø 50 mm ca. 32 mm
 Ø der Fläche bei Ø 60 mm ca. 32 mm
 Ø der Fläche bei Ø 70 mm ca. 37 mm
 Ø der Fläche bei Ø 80 mm ca. 45 mm
 Ø der Fläche bei Ø 90 mm ca. 47 mm
 Ø der Fläche bei Ø 100 mm ca. 50 mm
 Ø der Fläche bei Ø 120 mm ca. 62 mm

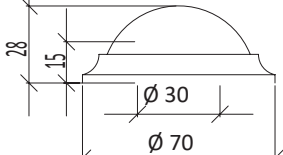
Artikel-Nr.	Grösse mm	Buche ged. .11	Eiche .13	Esche .14	Tanne .31	Ahorn .16	Treppenrosetten Roh, Ø 70mm, Bohrung Durchm. 30x15 mm Tiefe 
19.070. _ _	Ø 70 mm	7.50	10.70	9.10	7.50	10.70	

Andere Holzarten auf Anfrage

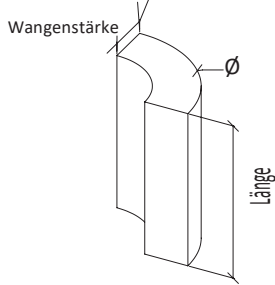
Artikel-Nr.	Aussen-durchmesser	Meterpreis Fr. Buche ged. .11	Meterpreis Fr. Eiche .13	Treppenfosten viertelrund Wangenstärke 55mm, geschliffen 
15.140. __	140 mm	186.—	203.50	
15.160. __	160 mm	186.—	203.50	
15.180. __	180 mm	186.—	203.50	
15.200. __	200 mm	200.—	282.70	
15.220. __	220 mm	217.40	311.30	
15.240. __	240 mm	233.—	331.70	
15.260. __	260 mm	314.60	486.20	
15.280. __	280 mm	400.40	499.—	
15.300. __	300 mm	423.50	542.—	
15.400. __	400 mm	534.60	720.—	
Wangenstärke 40-55mm = Preise wie oben 56-60mm = Zuschlag Fr./m 20.-		Treppenfosten sind auch in anderen Holzarten erhältlich. Grössere Mengen müssen offeriert werden.		

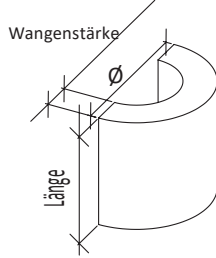
Artikel-Nr.	Aussen-durchmesser	Meterpreis Fr. Buche ged. .11	Meterpreis Fr. Eiche .13	Treppenfosten halbrund Wangenstärke 55mm, geschliffen 
14.140. __	140 mm	317.70	473.—	
14.160. __	160 mm	317.70	473.—	
14.180. __	180 mm	317.70	473.—	
14.200. __	200 mm	338.—	532.30	
14.220. __	220 mm	369.—	576.—	
14.240. __	240 mm	393.70	672.60	
14.260. __	260 mm	650.—	1007.50	
14.280. __	280 mm	670.—	1081.60	
14.300. __	300 mm	893.—	1157.60	
14.400. __	400 mm	1338.50	1610.—	
Wangenstärke 40-55mm = Preise wie oben 56-60mm = Zuschlag Fr./m 20.-		Treppenfosten sind auch in anderen Holzarten erhältlich. Grössere Mengen müssen offeriert werden.		

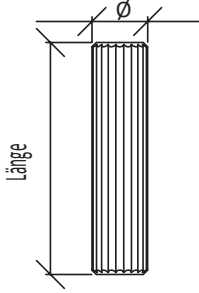
Artikel-Nr.	Durchmesser mm	ca. Stück kg	kg-Preis Fr.	Dralldübel abgelängt gerillt, gefasst, abgelängt 
35.508.30	8/30	982	13.90	
35.508.35	8/35	842	13.70	
35.508.40	8/40	736	13.40	
35.508.50	8/50	589	13.20	
35.510.30	10/30	628	11.10	
35.510.35	10/35	539	10.90	
35.510.40	10/40	471	10.70	
35.510.50	10/50	377	10.40	
35.512.30	12/30	436	10.20	
35.512.40	12/40	327	9.30	
35.512.50	12/50	262	9.—	
35.512.60	12/60	218	8.80	

Auf Anfrage offerieren wir Ihnen gerne andere Ø und Längen

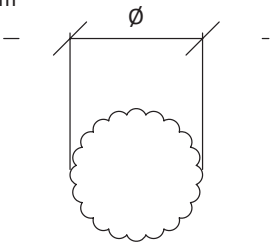
Artikel-Nr.	Durchmesser mm	Meterpreis ungeschliffen	Rundstäbe gerillt Buche, in Längen von ca. 1000mm 
35.006.12	6	— .50	
35.008.12	8	— .50	
35.010.12	10	— .60	
35.012.12	12	— .60	
35.014.12	14	— .85	
35.015.12	15	1.—	
35.016.12	16	1.10	
35.018.12	18	1.30	
35.020.12	20	2.30	

Andere Längen auf Anfrage.
Alle Rundstäbe sind auch geschliffen lieferbar.

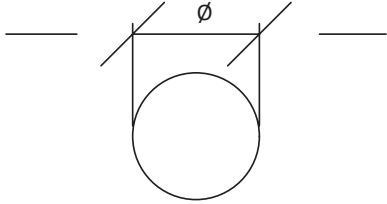
Artikel-Nr.	Durchmesser mm	Meterpreis ungeschliffen	Rundstäbe glatt Buche, in Längen von ca. 1000mm
34.006.12	6	— .40	
34.008.12	8	— .50	
34.010.12	10	— .55	
34.012.12	12	— .70	
34.014.12	14	— .90	
34.015.12	15	1.—	
34.016.12	16	1.10	
34.018.12	18	1.30	
34.020.12	20	1.60	
34.025.12	25	2.50	
34.030.12	30	3.80	
34.035.12	35	9.30	
34.040.12	40	11.50	

**Andere Längen auf Anfrage.
Alle Rundstäbe sind auch geschliffen lieferbar.**

Verschiedene Spezial-Profile fertigen wir in diversen Holzarten nach Ihrem Muster oder Ihrer Zeichnung.
Für Fragen stehen wir gerne zur Verfügung und erstellen Ihnen auch eine persönliche Offerte.

**Leisten
4 Kant oder Profiliert**

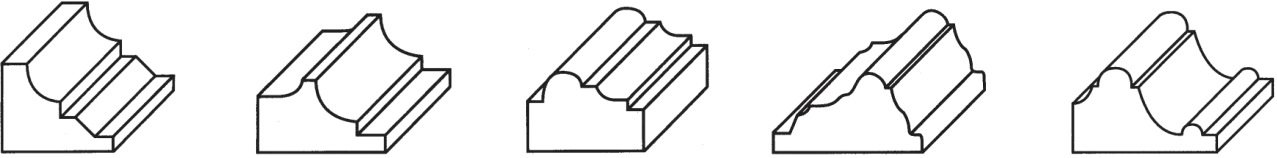

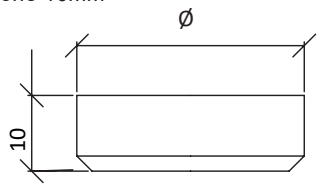
Artikel-Nr.	Durchmesser mm	ca. Stück kg	kg-Preis Fr.	Ast-Flickzapfen Fichte
35.815.31	15	1100	20.40	Höhe 10mm 
35.820.31	20	650	19.15	
35.825.31	25	400	19.15	
35.830.31	30	300	19.10	
35.835.31	35	200	19.15	
35.840.31	40	160	19.15	
35.845.31	45	130	21.25	
35.850.31	50	100	21.25	

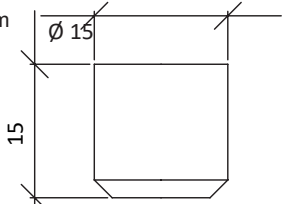
Artikel-Nr.	Durchmesser mm	ca. Stück kg	kg-Preis Fr.	Ast-Flickzapfen Eiche
35.815.13	15	500	— .50/Stk.	Höhe 15mm 

Preise

Die Notierungen unserer Offerten und Preislisten sind freibleibend und ohne Verbindlichkeit. Sie können von uns jederzeit und ohne vorherige Anzeige geändert werden. Sie verstehen sich für die der Anfrage zugrundegelegten Mengen und Materialien, exkl. MwSt., Verpackung und Transport. Sie basieren auf den am Tage der Bestätigung bekannten Löhne, Kosten, Abgaben und Wechselkurse. Erhöhen sich diese in der Zeit bis zur Auslieferung, behalten wir uns vor, die Preise entsprechend anzupassen.

Konditionen

Unsere Konditionen lauten: 30 Tage netto.
Andere Vereinbarungen bedürfen der schriftlichen Form.

Kleinmengenzuschlag

Bei Warenbeträgen unter Fr. 200.– verrechnen wir einen Kleinmengenzuschlag von Fr. 15.–

Termine und Lieferung

Die angegebenen Lieferfristen werden nach Möglichkeit eingehalten, sind aber unverbindlich. Bei allfälliger Überschreitung der Fristen ist der Besteller nicht berechtigt, den Auftrag zu annullieren oder Schadenersatz zu fordern.

Rabatte

Barzahlungsrabatt: 5% auf Preislisten-Preise

Beanstandungen und Rückgabe

Beanstandungen bezüglich Quantität oder Qualität der Ware können nur dann entgegengenommen werden, wenn sie innerhalb von 8 Tagen nach Ankunft der Sendung schriftlich erfolgen. Wegen Fabrikationsmängeln oder aus anderen Gründen nachweisbar unbrauchbare Ware wird bei Franko-Rückgabe kostenfrei instand gestellt oder ersetzt. Weitergehende Ansprüche anerkennen wir nicht.

Garantien

Diese beschränkt sich auf den Ersatz mangelhafter Ware. Weitergehende Kostenforderungen werden nicht anerkannt. Eine weitergehende Haftung als die des Lieferwerkes ist ausgeschlossen.

Holz ist ein Naturprodukt und hat auf Grund seiner Herkunft in Farbe und Struktur zum Teil massive Abweichungen die vom Kunden akzeptiert werden müssen. Das Risiko und die Garantie bei nicht einwandfreier Lagerung, bei unfachmässiger Ausführung und ungeeigneten Verwendungszwecken gehen zu Lasten des Käufers.

Rücktritt

Erteilte Aufträge für Anfertigungen können nur annulliert oder geändert werden, wenn die Ware noch nicht in Produktion ist. Ansonsten muss die Ware übernommen werden.

Erfüllungsort

Gemeinsamer Erfüllungsort und Gerichtsstand für alle sich aus Geschäften mit uns ergebenden Rechte und Pflichten ist Wil SG.